

BF02-BF02K

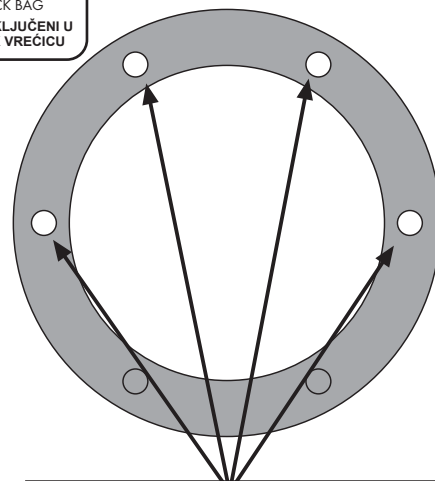

Rimuovere le viti originali
Remove the original screws
Enlevez les vis originales
Entfernen Sie die Originalschrauben
Mover los tornillos originales
Uklonite originalne vijke

- In base al numero e alle posizioni di viti originali corte e lunghe, che si trovano sul modello di moto sul quale si sta montando la flangia, seguire il montaggio raffigurato in fig.A o in fig.B
- According to the number and positions of the short and long original screws founded on the motorcycle model on which the flange will be mounted, follow the assembly shown in fig.A or fig.B
- En fonction du nombre et de la position des vis d'origine courtes et longues, qui se trouvent sur le modèle de moto sur lequel la bride sera montée, suivez le montage illustré sur la figure A ou la figure B
- Según el número y a las posiciones de los tornillos originales cortos y largos, que dispone el modelo de moto donde se montara el adaptador metálico, sigue el montaje mostrado en la figura A o en la figura B
- Prema broju i položajima kratkih i dugih originalnih vijaka na modelu motocikla na koji ce se prirubnica montirati, slijedite sklop prikazan na sl. A ili sl. B

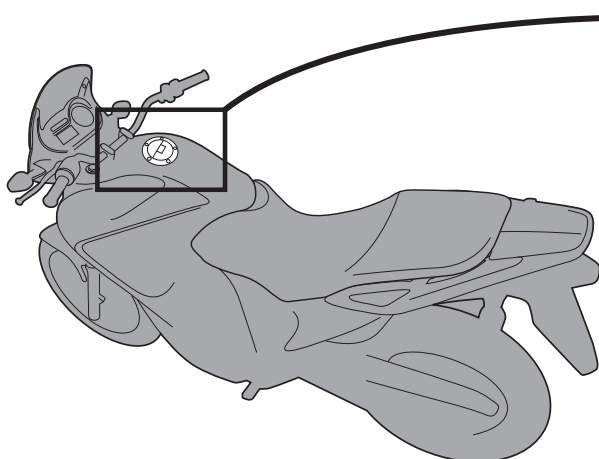
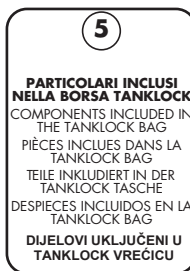
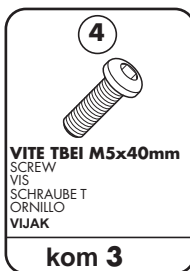
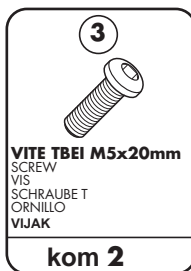
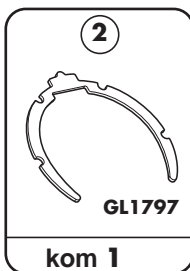
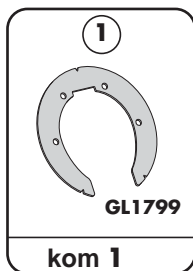